

HOIST POWER CIRCUIT

HOIST CONTROL CIRCUIT

HOISTING POWER
(A1/3)(A1/3)(A1/3)(A1/3)

----- PENDANT SWITCH -----
UP DOWN

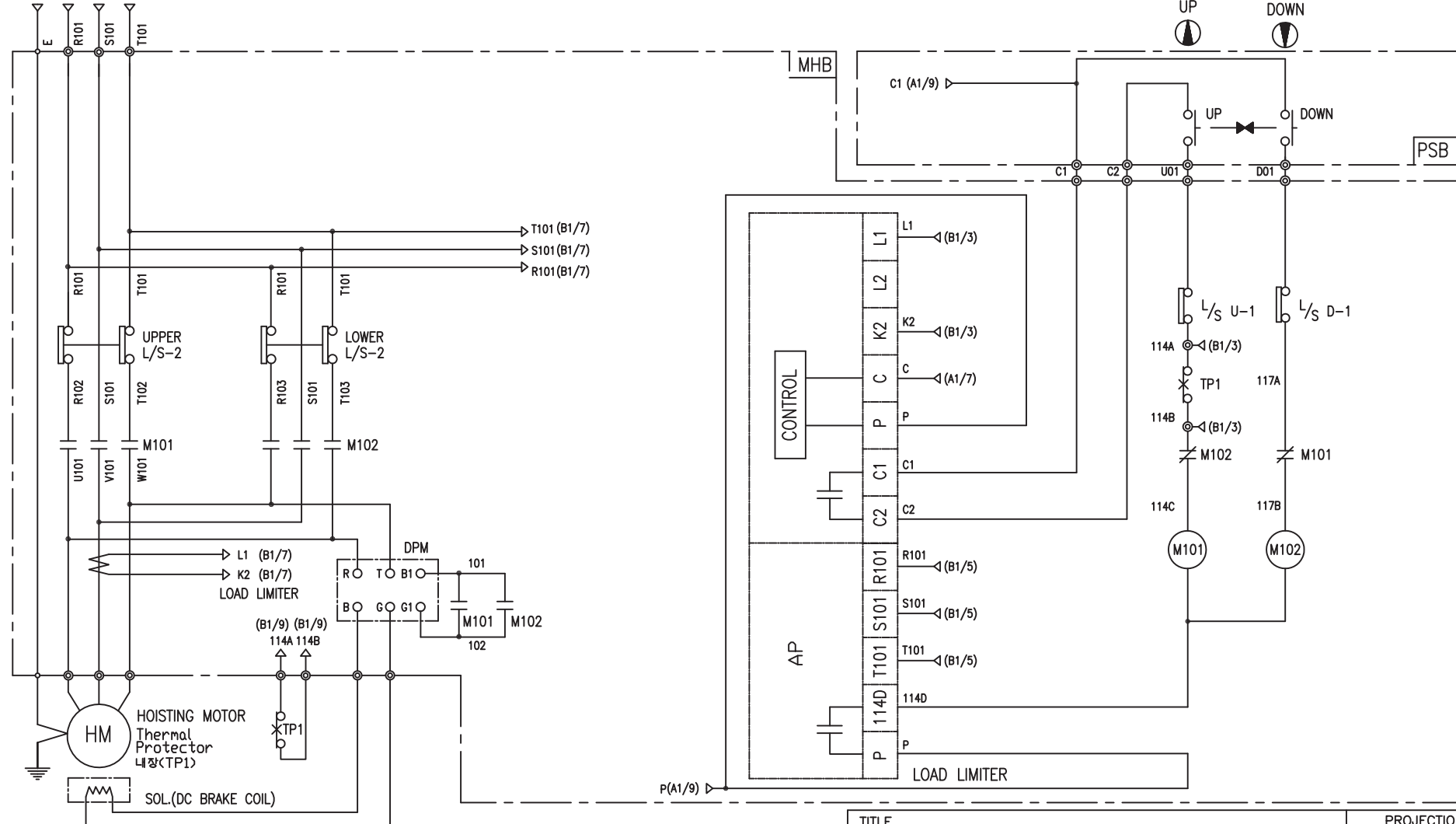

-NOTE-
1. : Mechanical Interlock

SPECIFICATION	MAGNET CONTACT		LOAD LIMITER	SILICON RECTIFIER				Thermal Protector	HOIST MOTOR
SYMBOLS	M101, M102		-	DPM				TP1	HM
DESCRIPTION	DMC-12	GMC-12	LKDL-601	AC220V	AC440V	AC460V	AC480V	17AM032	1.8Kw * 4P
				DC99V	DC198V	DC207V	DC216V		
MAKER	DONG-A	LS	LK	LK				Texas Instruments	LK

TITLE HOIST POWER & CONTROL CIRCUIT DIAGRAM						PROJECTION 	
WORK NO.	WORK NAME					SCALE	Q' TY
602	DA					1/1	1
220V, 440V, 460V, 480V							
DRAWN	CHECKED	REVIEWED	APPROVED	MODEL	DA		
LEE.G.H				CODE NO			
2010.07.30							
L K HOIST CO., LTD.							

SCHEDULE OF TECHNICAL DATA

1. SERVICE	HOISTING
2. MANUFACTURE	LK HOIST CO. LTD
3. MOTOR MODEL NO	1.8 - 4 - 46
4. RATED POWER	1.8 KW × 4 P
5. RATED VOLTAGE AND FREQUENCY	460 V 60HZ
6. MOTOR TYPE	SQUIRREL CAGE ROTOR TYPE
7. RATING	30 MIN
8. LOCATION	IN-DOOR , OUTDOOR
9. INSULATION CLASS	B
10. DESIGN TEMPERATURE RISE (BY RESISTANCE)	80℃
11. FULL LOAD SPEED	1740 RPM
12. FULL LOAD CURRENT	4.5 A
13. STARTING CURRENT AT RATED VOLTAGE	22.2 A
14. MINIMUM STARTING VOLTAGE	397 V
15. EFFICIENCY AT 100% RATED LOAD	72.4 %
16. POWER FACTOR AT 100% RATED LOAD	69.4 %
17. STARTING TORQUE	246 %
18. TYPE OF ENCLOSURE	전폐형
19. TYPE OF BEARING	PL : 6008DD OPL : 6207ZZ
20. MOUNTING	VERTICAL
21. MAXIMUM AMBIENT TEMPURE	40℃
22. BEARING LUBRICATION	GREASE
23. STARTING METHOD	FULL VOLTAGE